

14.000 SERIE

ROCKER SWITCHES



SPECIFICATIONS:

ELECTRICAL CHARACTERISTICS: 15A with resistive load

120 VAC or 10A with resistive load 250 VAC. (Q contact)

CONTACT RESISTANCE: maximum of 20 miliohms with 1A DC.

INSULATION RESISTANCE: minimum of 1.000 megaohms.

DIELECTRIC WITHSTAND: 1000 V (rms) for 1 minute (minimum).

OPERATION TEMPERATURE: from 0°C to 55°C.

REFERENCES

Single Pole

Reference			
14.101	ON	-	ON
14.103	ON	OFF	ON
14.105	(ON)	OFF	(ON)
14.107	ON	OFF	(ON)
14.108	ON	-	(ON)
14.123	ON	-	OFF
14.127	(ON)	-	OFF

Double Pole

Reference			
14.201	ON	-	ON
14.203	ON	OFF	ON
14.205	(ON)	OFF	(ON)
14.207	ON	OFF	(ON)
14.208	ON	-	(ON)
14.211	ON	ON	ON
14.213	ON	ON	(ON)
14.215	(ON)	ON	(ON)
14.223	ON	-	OFF
14.227	(ON)	-	OFF

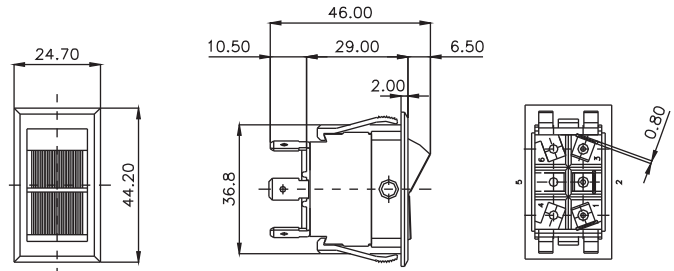

() Momentary

* Possilbe options with lamp 120/250VCA.

Four-Pole

Reference			
14.401	ON	-	ON
14.403	ON	OFF	ON
14.405	(ON)	OFF	(ON)
14.407	ON	OFF	(ON)
14.408	ON	-	(ON)
14.411	ON	ON	ON
14.413	ON	ON	(ON)
14.415	(ON)	ON	(ON)
14.423	ON	-	OFF
14.427	(ON)	-	OFF

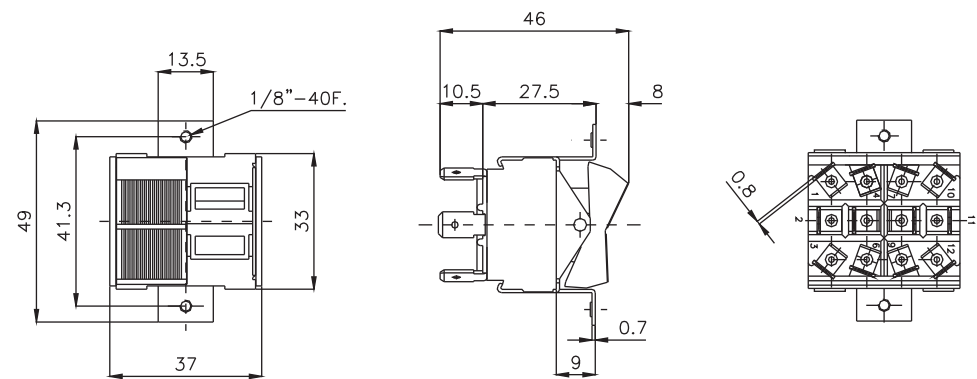

SUPPORT

S1C - cut 3,5 mm.

S1R - thread R.1/8"-40F-W

S1F - hole Ø 4,0 mm.

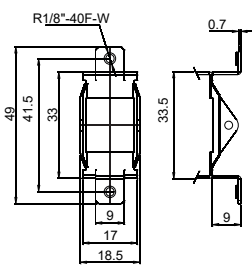

S1R

S2C - cut 3,5 mm.

S2R - thread R.1/8"-40F-W

S2F - hole Ø 4,0 mm.

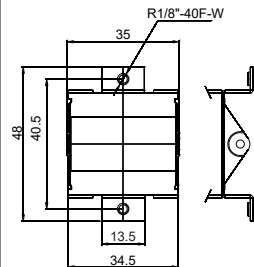

S2R

S3C - cut 3,5 mm.

S3R - thread R.1/8"-40F-W

S3F - hole Ø 3,5 mm.

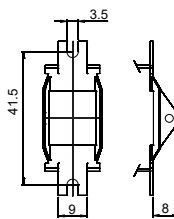

S3C

S4R - thread R.1/8"-40F-W

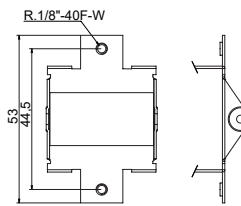

S4R

S5R - rosca R.1/8"-40F-W

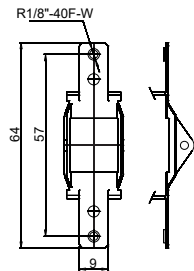

S5R

14.000 SERIE

FRAME - M#

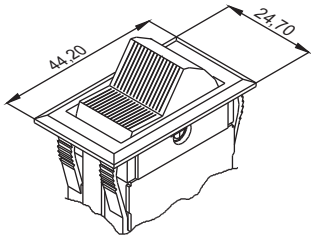

CUT FOR FIT

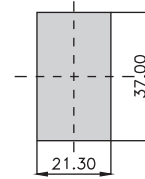

POLYAMIDE ACTUATOR

T1#

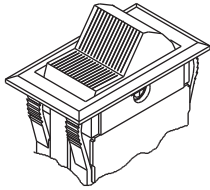

T2#

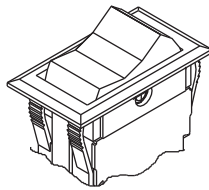

T3##

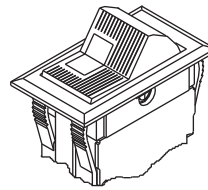

R1#

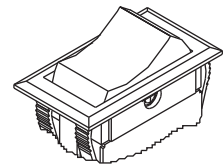

T5#

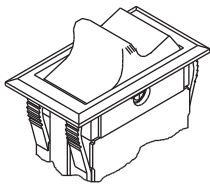

T6#

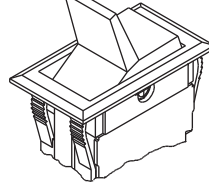

T7##

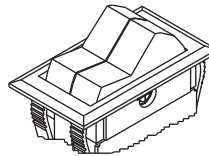

T20#

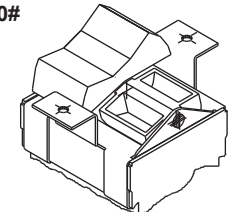

TERMINALS

E1 - Quick connect
2,8 x 0,5 (standard)

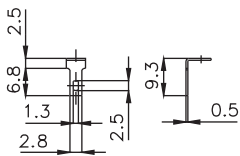

E2 - Quick connect 4,8 x 0,5

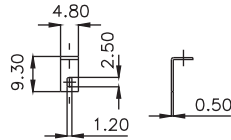

E3 - Faston 6,3 x 0,8

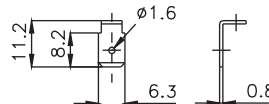

P1 - Screw

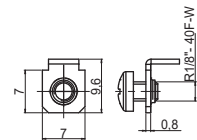

CONTACTS

Q
15A with resistive load 120VAC
10A with resistive load 250VAC

G
20A with resistive load 120VAC
15A with resistive load 250VAC

- COLORS

Note: Substitute # by the code of requested color.

- A - blue
- B - white
- C - yellow
- D - green
- E - red
- F - black - (standard)
- G - gray
- H - brown

NOTES:

T3 - Light rocker - choose color and finder reference.
Ex: T3FE - black rocker and red finder.

T7 - Double rocker - both rockers must be codified.
Ex: T7BA - one white rocker and one blue rocker.

SELECTION GUIDE

SUPPORTS

Reference	Support	actuator	terminal	contact
S1	C	T1#	E1	Q
S3	R	T2#	E2	G
S5	F	T3#	E3	
S2	C	T20#	P1	
	R			
	F			
S4	R			

FRAMES

Reference	frame	actuator	terminal	contact
M#	M#	T1#	E1	Q
		T2#	E2	G
		T3##	E3	
		R1#	P1	
		T5#		
		T6#		
		T7##		