

TOMADAS PARA APARELHOS

ESPECIFICAÇÕES:

CARACTERÍSTICAS ELÉTRICAS: 10A ou 20A em tensões de até 250V~.

Modelos com poço externo ou interno atendem ao padrão brasileiro de plugues e tomadas (NBR 14136).

Produtos certificados pelo Inmetro (versões com terminais de parafuso) ou certificados pelo Bureau Veritas (versões com outros tipos de terminais).

interruptores para aparelhos



Referência	N° de Condutores	Poço
TPA1 - 3	3 (2P+T)	Externo
TPA2 - 3	3 (2P+T)	Interno

POÇO EXTERNO



POÇO INTERNO

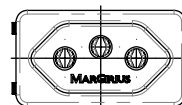

DIMENSÕES

POÇO EXTERNO

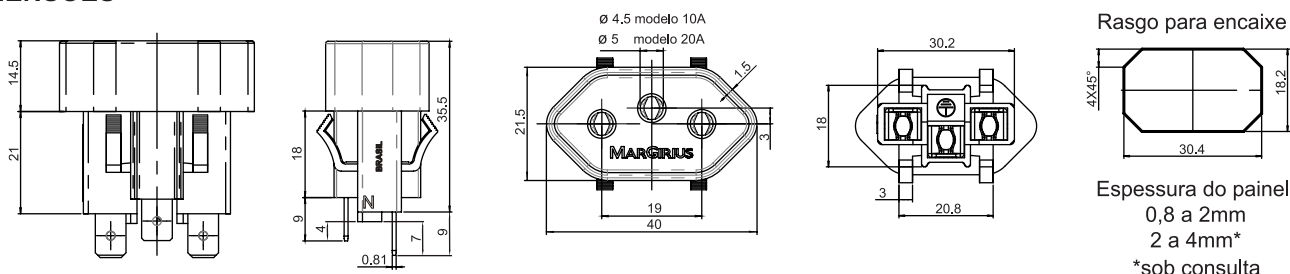

POÇO INTERNO

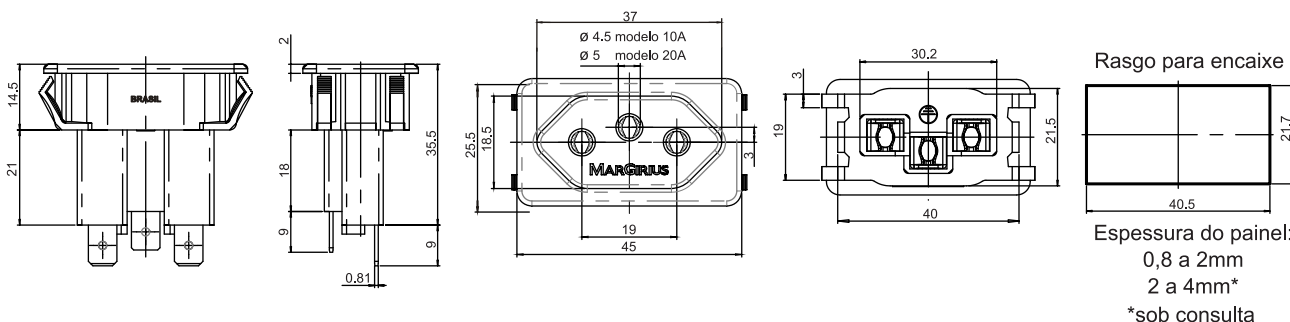

TERMINAIS

E2* - Faston
4,8 x 0,8mm

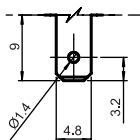

E3 - Faston
6,3 x 0,8mm

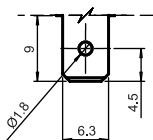

E4 - Faston c/rasgo
6,3 x 0,8mm

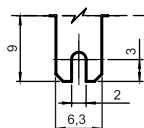

E5 - Solda
2,8 x 0,8mm

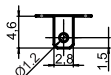

E6 - Solda
6,3 x 0,8mm

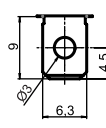

CI - Terminal
PC

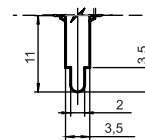

P1 - Parafuso

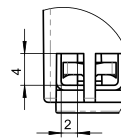

*Terminal E2 somente para tomadas de 10A.

- CORES

A - azul
AC - creme
B - branco
C - amarelo
D - verde
E - vermelho
F - preto - (standard)
G - cinza
H - marrom

CONTATOS

10A
20A

BARRA DE CODIFICAÇÃO

TPA □□□□ - □ □ □ □ □
Referência Terminal Cor Contatos
TPA1 - 3 E2 E3 10A
TPA2 - 3 E4 E5 E6 20A
CI P1
Cabo

Cabo - Rabicho 150mm*
3 x 1,5mm²

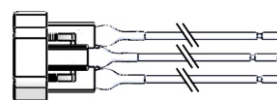

*Outros comprimentos e bitolas sob consulta